

3-Level Inverter  
Power Modules  
For Solar and UPS market

# 3-Level Inverter

- **Also called Neutral Point Clamped (NPC) Inverter**
  - Used in 3-phase inverter
  - Can operate under 1000Vdc bus with 600V transistors
  - Allow faster operation with lower losses = higher efficiency
  - Trench IGBT for operating frequency <20kHz
  - Fast NPT IGBT for operating frequency >20kHz
  - Mix CoolMOS/Trench IGBT for unbeatable efficiency

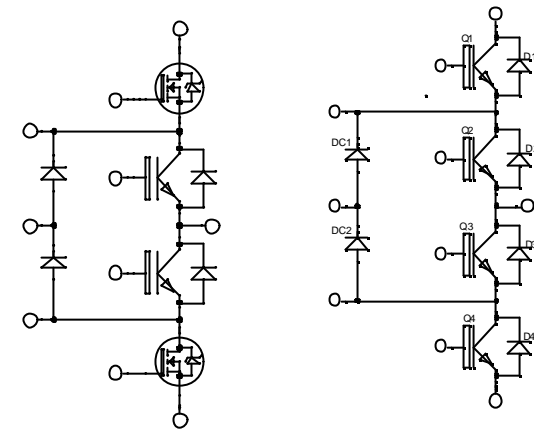

- **Key Features**

- Low profile package (SP1, SP3, SP6)
- Very high efficiency up to 98%
- Possibility to use SiC diodes to further improve efficiency up to 3% more than normal phase leg using 1200V devices
- Very low inductive internal design and package
- Temperature Sensor (NTC) in SP3 design
- SP1 with no NTC for very cost effective solution

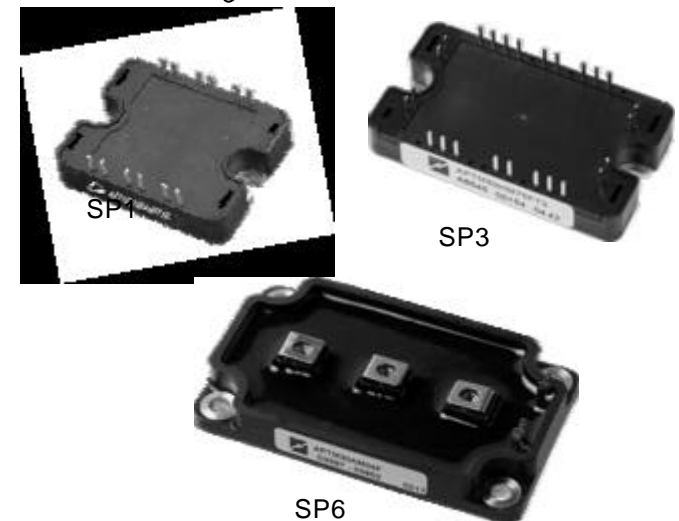

## 3-Level Inverter

- **APPLICATIONS**
  - Inverter
  - Distributed power generation
  - Converter
- **MARKETS**
  - Solar inverter
  - UPS

## 3-Level Inverter

Three level inverter modules						
VCES (V)	Technology	IC (A) Tc=80 C	Vce(on) (V) at rated Ic	Package	NTC	Part Number
600	TRENCH	300	1.5	SP6	-	APTGT300TL60G
		200	1.5	SP6	-	APTGT200TL60G
		150	1.5	SP6	-	APTGT150TL60G
		100	1.5	SP3	YES	APTGT100TL60T3G
		75	1.5	SP3	YES	APTGT75TL60T3G
		50	1.5	SP3	YES	APTGT50TL60T3G
		50	1.5	SP1	-	APTGT50TL601G
		30	1.5	SP3	YES	APTGT30TL60T3G
		30	1.5	SP1	-	APTGT30TL601G
		20	1.5	SP3	YES	APTGT20TL60T3G
	20	1.5	SP1	-	APTGT20TL601G	
	NPT fast	50	2.1	SP3	YES	APTGF50TL60T3G
		30	2.1	SP3	YES	APTGF30TL60T3G
		30	2.1	SP1	-	APTGF30TL601G
1200	TRENCH	50	1.7	SP3	YES	APTGT50TL120T3G
VCES (V)	Technology	Rdson Coolmos (mOhms)	Vce(on) (V) IGBT at rated Ic	Package	NTC	Part Number
600	Mix Coolmos/Trench IGBT	45	1.5/75	SP3	YES	APTCV60TLM45T3G
		83	1.5/50	SP3	YES	APTCV60TLM83T3G
		99	1.5/30	SP3	YES	APTCV60TLM99T3G
		99	1.5/30	SP1	-	APTCV60TLM991G
900		120	1.7/50	SP3	YES	APTCV90TL12T3G

# 3-Level Inverter



















## STANDARD POWER MODULES

click any  below to view products

Configuration	IGBT 600V	IGBT 1200V	IGBT 1700V	MOSFET 75-500V	MOSFET 600-1200V	CoolMOS 600-800V	Diode 200-1700V
Gate Driver Module							
3 Phase Bridge							
<b>3 Level Inverter</b>							
Asymmetrical Bridge							
Boost Chopper							
Boost Chopper + Full Bridge							
Dual Boost Chopper							
Buck Chopper							
Dual Buck Chopper							
Dual Common Source							
Triple Dual Common Source							
Full Bridge							
Full Bridge + Series and Parallel Diodes							
Phase Leg							
Phase Leg + Series Diodes							
Phase Leg + Series and Parallel Diodes							
Triple Phase Leg							
Single Switch							
Single Switch + Series Diodes							
Single Switch + Series and Parallel Diodes							
Single Diode							
Dual Diode							
Dual Common Anode Diode							
Dual Common Cathode Diode							

[ 18 of 18 ]

Click on pkg to open detailed pkg specification

	BV(CES) (V)	IC(A) @ T <sub>c</sub> =80°C	VCE(sat) (V)	NTC	Package Style	Data Sheet	Part No
<b>DC/AC Inverter (NPT/Trench IGBT)</b>							
	600	300	1.5	N/A	SP6		<a href="#">APTGT300TL60Q</a>
	600	200	1.5	N/A	SP6		<a href="#">APTGT200TL60Q</a>
	600	150	1.5	N/A	SP6		<a href="#">APTGT150TL60Q</a>
	600	100	1.5	Yes	SP3		<a href="#">APTGT100TL60T3Q</a>
	600	75	1.5	Yes	SP3		<a href="#">APTGT75TL60T3Q</a>
	600	50	2.1	Yes	SP3		<a href="#">APTGF50TL60T3Q</a>
	600	50	1.5	N/A	SP1		<a href="#">APTGT50TL601G</a>
	600	50	1.5	Yes	SP3		<a href="#">APTGT50TL60T3Q</a>
	600	30	2.1	N/A	SP1		<a href="#">APTGF30TL601G</a>
	600	30	2.1	Yes	SP3		<a href="#">APTGF30TL60T3Q</a>
	600	30	1.5	N/A	SP1		<a href="#">APTGT30TL601G</a>
	600	30	1.5	Yes	SP3		<a href="#">APTGT30TL60T3Q</a>
	600	20	1.5	N/A	SP1		<a href="#">APTGT20TL601G</a>
	600	20	1.5	Yes	SP3		<a href="#">APTGT20TL60T3Q</a>
<b>DC/AC Inverter (CoolMOS/Trench IGBT)</b>							
	600	75	1.5	Yes	SP3		<a href="#">APTCV60TLM45T3Q</a>
	600	50	1.5	Yes	SP3		<a href="#">APTCV60TLM70T3Q</a>
	600	30	1.5	N/A	SP1		<a href="#">APTCV60TLM991G</a>
	600	30	1.5	Yes	SP3		<a href="#">APTCV60TLM99T3Q</a>



SP6



SP3



SP1

Data sheet available at  
[www.microsemi.com](http://www.microsemi.com)